

# TECMA

by THETFORD

# EasyFit



## Owner's Manual



### Congratulations...

...on your purchase of the Tecma **EasyFit** marine toilet. Please read this Manual completely to ensure satisfaction. Thetford's Technical Support Team is committed to providing quality service and parts for your high-quality, high-tech marine toilet.

### Features

- Contemporary design and compact size.
- Glazed vitreous china bowl for homelike appearance, maximum flush performance, easy cleaning and minimal maintenance. Available in white or bone color, and short or standard profiles.
- Enamel-coated wood seat and cover provide firm support.
- Programmable Wall Switch allows installer/user to increase or decrease level setting for water refill. Includes both black and bone Bezel.
- Wall Switch Keypad includes Power-On, Tank Level and Lock-Out indicators.
- Lock-Out electronics prevent flushing if holding tank is full.
- User-selectable water refill level.
- Quiet flush operation.
- Standard nozzle flush system and vertical outfall insures complete bowl coverage and low water use.
- Easy to winterize using common, non-toxic propylene glycol.

- Optimized for minimal water use:
  - 1.75 liters/flush for liquid waste
  - 2.25 liters/flush for solid waste
- Fully-integrated, non-corroding pump/motor system macerates waste and resists clogging. Available in 12- or 24-volt configurations. Capable of discharging waste 6 feet (2 m) above toilet.

### Warranty

Tecma EasyFit has a Limited 2-Year Warranty. This Warranty does not apply to applications where toilet can be exposed to shock levels in excess of 10 g's and has been installed without specific base isolation dampening. See the Tecma EasyFit Installation Manual for installation guidelines.

### Questions?

If you have any questions or need assistance, please contact Tecma Service at 1-800-543-1219.

## WARNING!

**THE WARNINGS BELOW MUST BE READ AND UNDERSTOOD BEFORE INSTALLATION, OPERATION, OR SERVICE OF UNIT BEGINS. ANY MODIFICATION OF THIS UNIT COULD RESULT IN PROPERTY DAMAGE, INJURY OR DEATH.**

**THETFORD CORPORATION ACCEPTS NO RESPONSIBILITY OR LIABILITY FOR DAMAGE TO EQUIPMENT, INJURY OR DEATH THAT MAY RESULT FROM PRODUCT'S IMPROPER INSTALLATION, SERVICE OR OPERATION.**

**THETFORD CORPORATION RECOMMENDS THAT ONLY A TRAINED AND QUALIFIED MARINE TECHNICIAN OR ELECTRICIAN INSTALL OR SERVICE THIS PRODUCT.**

### ***Danger of Electric Shock, Fire and Flooding***

Failure to heed these warnings can result in loss of property, injury and death.

- Always be sure unit's **ELECTRICAL POWER** is **TURNED OFF** and that **SEACOCKS** are **CLOSED** or in the "OFF" position before beginning work.

- If Toilet is connected to any through-hull fittings, **ALWAYS CLOSE or TURN OFF ALL SEACOCKS** when **BOAT IS UNATTENDED** – even if only for a minimal time.
- For units using fresh water that are (at any time) connected to shoreside municipal water supply systems, **SHORESIDE SYSTEM** must be **DISCONNECTED IF BOAT IS LEFT UNATTENDED** – even if only for a minimal time.
- **IF WATER DOES NOT FLOW INTO TOILET DURING THE FIRST TWO OR THREE FLUSH CYCLES**, it has been improperly installed or has malfunctioned. Discontinue use of toilet until installation has been corrected or repairs are made. Please review this manual's Installation section or refer to the Troubleshooting section.
- Only human waste and toilet paper should be put into the toilet. Never flush **FOREIGN MATERIALS** (e.g. paper towels, pre-moistened wipes, condoms, feminine hygiene products, dental floss, household garbage, etc.).

# Operation

The toilet's wall switch control has two primary functions:

- An ADD WATER button – Adds approximately 0.5L of water each time it is pushed momentarily. Electronics prevent overflow.
- A FLUSH button – Starts an add water and macerate sequence that runs the motor and adds water twice for maximum cleansing and minimum water usage. Sequence ends with a small amount of water added to the bowl to provide an odor trap. Recommended to minimize water use and for liquid waste disposal without adding water.

## ADD WATER

Recommended before flushing solid waste

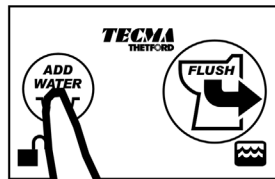

Adds approx. .5L of water.

Can be repeated, but only until max amount is reached.

## FLUSH

Recommended for flushing liquid waste (minimize water usage)

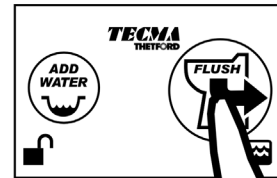

Starts FLUSH sequence

- Adds approx. .25L of water
- Macerates
- Adds .75L of water
- Refills bowl

The amount of water refilled into the bowl can be adjusted per the Water Refill Programming Mode

## EasyFit Service Kits

1. Seat & Cover
2. Nozzle
3. Controller
4. Pump & Discharge Tube
5. Motor Bracket
6. Water Inlet
8. Floor Mount Hardware
9. J-Bolt
11. Discharge Tube
12. Grommet
13. Wall Switch
14. Bezel
15. Lower Discharge Check Valve

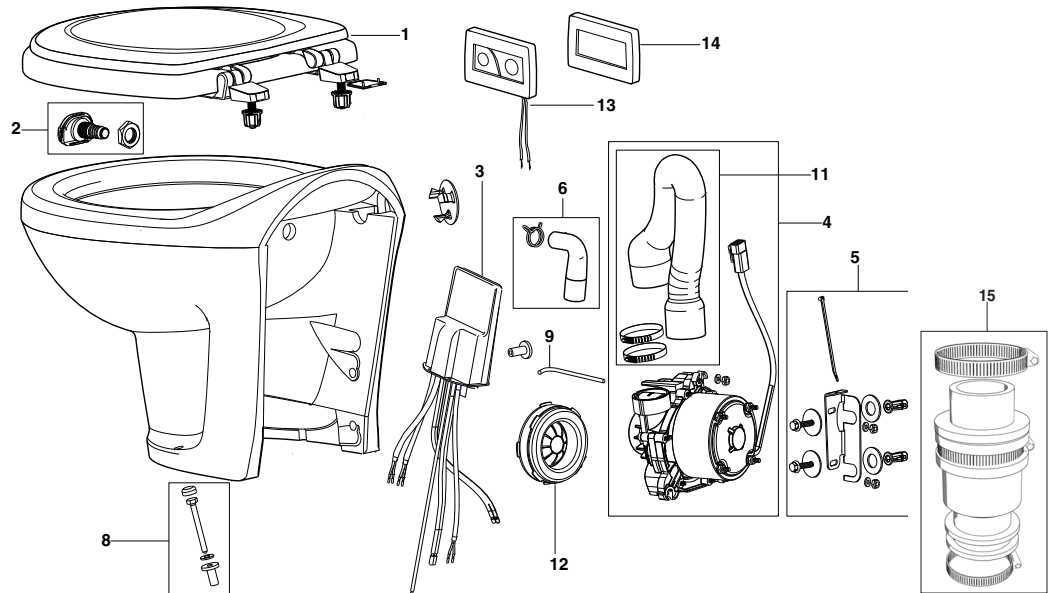

## Lighting

- Blue backlighting of the buttons provides identification at night. Buttons shut off to preserve power if not used for an extended interval (see Sleep Mode, next page).
- A red warning light in the lower left corner indicates full-tank lockout protection is off.
- The holding tank indicator in lower right corner normally is green. It turns red to show the holding tank is full (or nearly full) and the flush lockout is activated.

### Lighting of tank LED

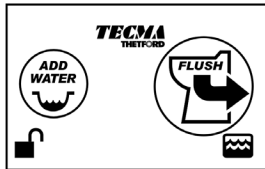

Symbol not lighted-toilet system is OFF, or not receiving power.

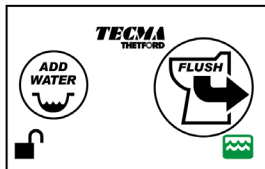

Symbol lighted Green-toilet system is ON, and the holding tank is less than half full.

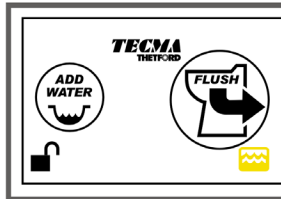

Optional Mid Tank Sensor  
Symbol lighted Yellow-toilet system is ON, and the holding tank is at least half full.

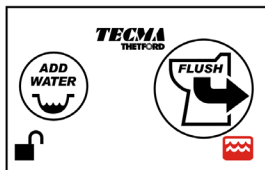

Symbol lighted Red-toilet system is ON, and the holding tank is full.

## Flush Lockout

This toilet is equipped with an electronic holding tank level sensing feature that automatically prevents FLUSH button operation when the holding tank is full and, thus, prevents waste overflow.

### Single Flush Override of Flush Lockout

If holding tank is full, system will not allow a flush to occur. (If a flush is taking place, it will be completed.) This can be overridden by holding the FLUSH button for about 8 seconds.

This override function is intended for emergency use only. Because the sensor is not located at the exact top of a tank, the override function can be used about 5 times before overflowing. Size and shape of the holding tank determine the actual number of times it can be used. Contact manufacturer for more detailed information.

**WARNING:** An excess of flushes after flush lockout is disabled can cause waste to overflow tank through plumbing. Thetford Corporation accepts no responsibility or liability for damage to equipment, or injury or death for overflow of waste holding tank when full-tank lockout is overridden. Waste holding tank should be checked after using EasyFit in override mode.

### Single flush override of flush Lockout

Toilet will not flush automatically when tank level indicator is red.

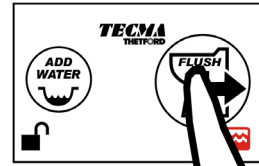

Press and Hold

(>8.0 sec.)

Initiates one flush

Flush Lockout reactivates

**CAUTION**

This single flush over-ride function can cause over filling of a waste tank. For Emergency Use Only.

### Disabling/Re-enabling Lockout Protection

Flush Lockout normally occurs when the holding tank becomes almost full. When this occurs, pushing the flush button causes tank symbol to flash, but does not cause a flush.

Enabling Lockout:

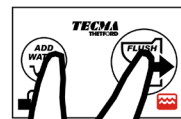

Press both buttons twice (.5 <, < 1.0 sec. 2 times)

Lockout ENABLED  
Unlock symbol light turns OFF

Disabling Lockout:

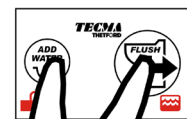

Press both buttons twice (.5 <, < 1.0 sec. 2 times)

Lockout DISABLED  
Unlock symbol light turns ON

**CAUTION**

Disabling the Toilet Lockout Function can cause overflowing of the waste tank. Emergency Use Only.

Note: This red symbol will remain on as long as lockout is disabled, even if the holding tank is emptied.

## Flush Modes

The toilet has two modes of operation: Marine and Residential. It is shipped in the Marine mode, which leaves the bowl with a minimal amount of water in the trap at the bottom of the bowl.

The Residential mode leaves the bowl with a greater amount of water, similar to a home toilet. Modes can be changed by a user (see diagram).

The toilet also has a Sleep mode to save power (see box below).

### Enter Water Refill Programming Mode

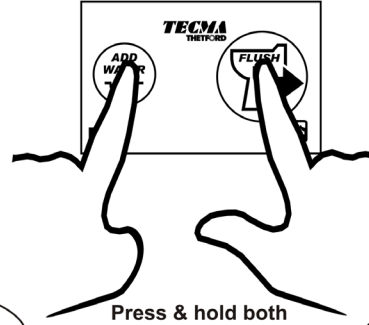

**MARINE MODE**  
Sets empty bowl mode after flush.

Press & hold both buttons for 3 seconds  
LEDs will flash  
programming mode will be entered

**RESIDENTIAL MODE**  
Sets water level in bowl after flush.

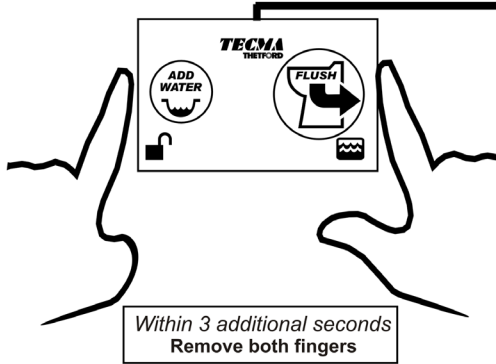

Within 3 additional seconds  
Remove both fingers

LEDs stop flashing

Toilet will now refill only trap at the bottom of bowl.

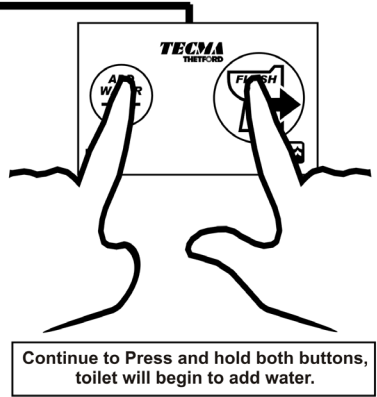

Continue to Press and hold both buttons,  
toilet will begin to add water.

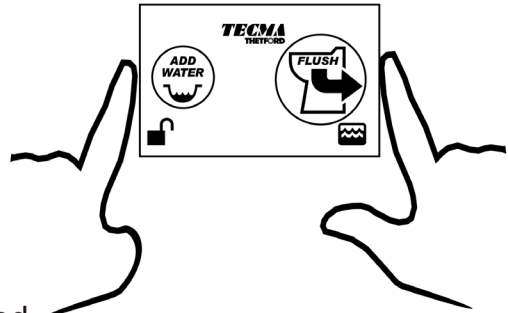

Release both buttons after 4 or 5 seconds  
(recommended to minimize water use)  
or at the desired flush water level.

LEDs stop flashing

This sets the amount of water that will be used in future flushes.

### Recommended water level depth

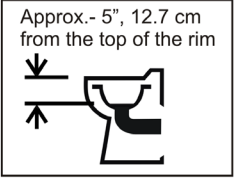

Approx. - 5", 12.7 cm  
from the top of the rim

### Sleep Mode

Lighting turns Off after 8 hours of non-use.

In Sleep Mode the switch LEDs will turn Off until next use.

Pushing either button will return lighting to full brightness.

To switch modes of operation, go to the top of this diagram to enter water refill programming mode.

## Correct Water Level Usage

Water usage is not adjustable in the Marine Mode.

The recommended water level in the Residential Mode is 5" below the toilet rim. To set this in the programming mode, release your fingers 4-5 seconds after water begins flowing into the toilet. Setting the water deeper than this level creates excessive water use and fills the holding tank too quickly.

**CAUTION: Raw Water systems are designed to perform optimally with pumps rated at approximately 3.0 Gallons per Minute (similar to the pump supplied). Lower rated pumps will provide a less vigorous flush, while use of higher-rated pumps will cause excessive water consumption.**

## Bowl Emptying

To empty bowl without adding water or starting a flush sequence, push and hold both buttons simultaneously until bowl contents are discharged. Pushing either button returns toilet to normal operation.

### Emptying the Bowl

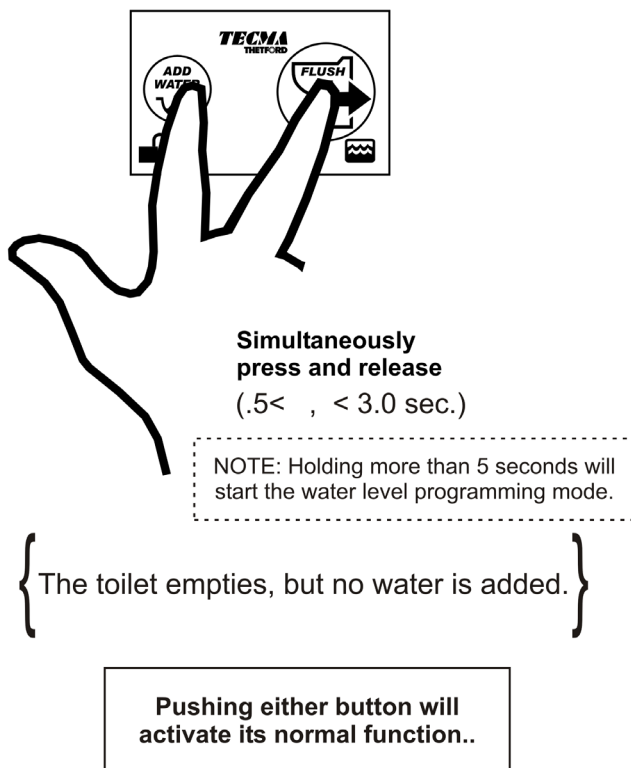

**CAUTION**

Refill the toilet as soon as possible after emptying the bowl. Leaving water out of the plumbing trap can result in objectionable odors.

## Maintenance

### Cleaning

Use Thetford's Aqua-Clean, a non-abrasive, all-purpose cleaner, on the bowl and macerator pump. It is specially formulated and thoroughly tested to be safe for all components of your toilet system. It safely removes iron stains and hard water deposits and can be safely used on many other surfaces, including countertops, sinks, showers and tubs. Just squeeze Aqua-Clean onto surface. Allow to sit a few minutes and clean with a sponge. For severely soiled toilets, allow Aqua-Clean to soak overnight.

Never use household cleaners, which can contain bleach, in the toilet system. Household toilet bowl cleaners contain harsh acids. Bleach, petroleum-based products, strong acids and abrasives can cause irreversible damage to the toilet system and components.

### Winterizing

Use only propylene glycol based, non-toxic antifreeze when storing toilet during freezing conditions.

**Never use automotive antifreeze or windshield washer solvent to winterize.**

Make sure that both the entire supply and discharge systems are thoroughly winterized to ensure complete protection for your system.

### Storage

When storing the system for more than two weeks, thoroughly clean toilet and hoses by flushing with Thetford's Aqua-Kem, SupremeGreen or Aqua-Clean.

### Deodorants

Thetford holding tank deodorants deliver exceptional deodorant performance, tank cleaning and waste digestion.

Formaldehyde-based deodorants like Thetford's Aqua-Kem deliver unsurpassed odor control even in the hottest conditions. SupremeGreen provides the best non-formaldehyde based odor control. Both are available as liquids in various sized bottles, granular in foil packets, and granular as water-soluble Toss-Ins.



Aqua-Zyme, a liquid available only in a 32-oz. bottle, provides enzyme-based waste digestion and odor control.

### Tissue

It is important to use a RV/Marine tissue that disintegrates rapidly, which household tissues cannot be relied upon to do. Thetford offers 1- and 2-ply tissues that are specifically made for rapid disintegration, yet provide household tissue softness and feel. Thetford continually tests its tissues to assure they dissolve rapidly.

## Troubleshooting Guide

<i><b>PROBLEM</b></i>	<i><b>CAUSE</b></i>	<i><b>ACTION/SOLUTION</b></i>
<b>Toilet does not flush or flush performance is poor</b>	Waste tank is full (tank indicator light on wall switch is RED)	Empty waste tank before continuing to use toilet. Override full tank lock-out. <b>WARNING: THIS MAY CAUSE WASTE TANK TO OVERFLOW.</b>
	Clog at pump inlet	Clear clog. <b>DO NOT</b> flush foreign objects.
	Solid object in macerator	Do not attempt to remove object from pump body. Contact Thetford/Tecma Service (1-800-521-3032). <b>DO NOT</b> flush foreign objects.
	Low voltage	Check that toilet supply voltage is 12V+/-2V (24V+/-2V) AND that there is no more than a 10% decrease in voltage when macerator is running. If voltage decreases more than this, there may be a wiring problem in the boat.
<b>Water does not enter bowl during flush or water add cycle</b>	Water supply line kinked or not connected	Check that supply line is properly connected to fresh water supply. Check for kinks in the supply line.
	No power to water pump	Check that fuse/circuit breaker has not tripped. Ensure all electrical connectors to pump are fully mated.
	Water supply has been turned off	Open water supply valves or reconnect power to supply pump.
	Solenoid not plugged into controller (where applicable)	Ensure wiring harness to solenoid is fully mated at both ends.
	Electronics control problem	Contact Thetford/Tecma Service (1-800-521-3032).
<b>Water level in bowl has changed after flush</b>	Flush refill mode has been changed	See "Programming" section in Owner's Manual.
<b>Water continues dripping briefly into bowl after flush cycle is complete</b>	Toilet is installed below water line with vacuum breaker in water supply line	Normal operation – if only a small amount of water drips from nozzle.
<b>Bowl drains dry after flush</b>	Water is siphoning out of bowl	Discharge hose from macerator pump bent. Straighten hose.
<b>Wall switch does not appear to light up or does not stay lit</b>	No power to toilet	Check that fuse/circuit breaker has not tripped. Ensure all electrical connector are fully mated.
	Wall switch not properly connected to toilet.	Ensure wall switch electrical connector is fully mated at controller.
	Wall switch has entered Sleep Mode	Wall switch enters Sleep Mode after eight hours of continuous inactivity but remains functional. No action required.
	Wall switch electronics problem	Contact Thetford/Tecma Service (1-800-521-3032).
<b>Toilet is inoperative and there is no lighting in the wall switch</b>	No power to toilet	Check that fuse/circuit breaker has not tripped. Ensure all electrical connector are fully mated. Contact Thetford/Tecma Service (1-800-521-3032).

**NOTE:** This Troubleshooting Guide is intended to provide a basic service aid in the case of incorrect toilet operation. If the suggested actions above do not resolve the issue, it may be necessary to bring unit in for professional service. **Thetford Customer Service – 1-800-521-3032**